

CARRIER STRIP DETAIL

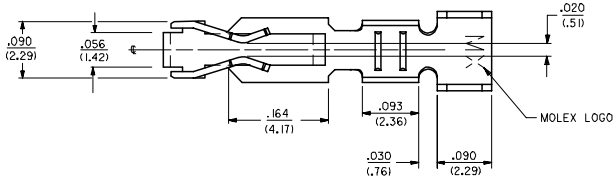

- NOTES:
1. MATERIAL; SEE LEGEND
 2. FINISH:
 - *909 - OVERALL HOT TIN DIF: .000100/(0.00254) MIN.
 - 102 - OVERALL TIN: .000200/(0.00508) MIN.
 - OVERALL COPPER: .000100/(0.00254) MIN.
 - 132 - OVERALL TIN: .000200/(0.00508) MIN.
 - OVERALL COPPER: .000200/(0.00508) MIN.
 - 503 - OVERALL HARD GOLD: .000030/(0.00076) MIN.
 - OVERALL NICKEL: .000050/(0.00127) MIN.
 - 550 - SELECT HARD GOLD: .000015/(0.00038) MIN.
 - OVERALL NICKEL: .000030/(0.00076) MIN.
 - OVERALL HARD GOLD FLASH: .000002/(0.00005) MIN.
 - 555 - SELECT HARD GOLD: .000015/(0.00038) MIN.
 - OVERALL NICKEL: .000030/(0.00076) MIN.
 - 558 - SELECT HARD GOLD: .000030/(0.00076) MIN.
 - OVERALL NICKEL: .000050/(0.00127) MIN.
 - OVERALL HARD GOLD FLASH: .000002/(0.00005) MIN.
 - 561 - SELECT HARD GOLD: .000030/(0.00076) MIN.
 - OVERALL NICKEL: .000050/(0.00127) MIN.
 - * THE PRIMARY SHIPPING CARTON WILL BE LABELED "COMPLIANT TO ROHS DIRECTIVE 2002/95/EC AND ELV ANNEX II OF DIRECTIVE 2000/53/EC." CARTONS WITHOUT THIS LABEL MAY CONTAIN PRODUCT WITH TIN-LEAD PLATING.
 3. PRODUCT SPECIFICATION: PS-40-02
 4. PACKAGING SPECIFICATION: CHAIN FORM SEE PK-6838-001
 5. TERMINAL FOR USE IN HOUSING NOS. 6442 AND 41695
 6. THIS PART WITH CRIMP FOR 22-26 AWG. WIRE. SEE DWG. NO. 7258
 7. CRIMP FOR 18 TO 20 GA. WIRE WITH MAX. INSULATION DIA. OF .100/(2.79). STRIP LENGTH OF .125/100 / (3.18/2.54)
 8. DIMENSIONS GIVEN ACROSS CENTERLINES ARE SYMMETRICAL ABOUT THOSE CENTERLINES WITHIN HALF THE TOTAL TOLERANCE.
 9. THIS PART CONFORMS TO CLASS B REQUIREMENTS OF COSMETIC SPECIFICATION PS-45499-002.

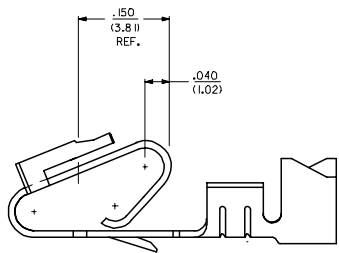

SELECTIVE PLATING LOCATION

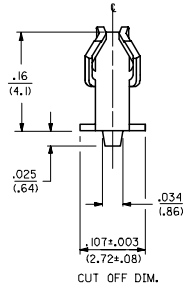

CUT OFF DIM.

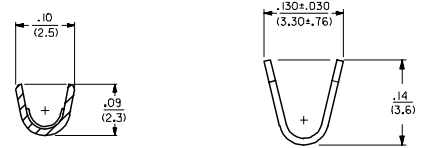
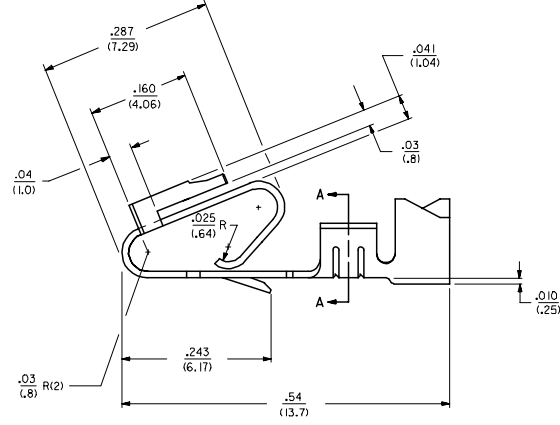

SECTION A-A

- LEGEND: 6838- ()
- WINDING
 - A= PER DETAIL A
 - BLANK= PER DETAIL B
 - FORM
 - BLANK= CHAIN
 - L= LOOSE
 - PLATING
 - SEE NOTE 2
- MATERIAL:
 (.27)/.0106 THK
 BLANK=BRASS
 A=PHOS BRONZE

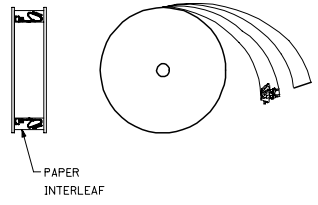

WINDING DETAIL 'A'

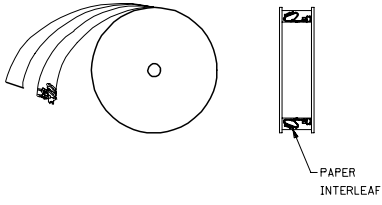

WINDING DETAIL 'B'

ADD NOTE 9 EC NO: UCP2008-0005 DRAWN BY: 2007/07/03 CHECKED BY: 2007/07/09 APPROVED BY: 2007/07/09 APPROVAL SIGNATURE:	QUALITY SYMBOLS ▽=0 ▽=0	GENERAL TOLERANCES (UNLESS SPECIFIED)		DIMENSION STYLE IN/MM		SCALE	DESIGN UNITS	THIRD ANGLE PROJECTION	TITLE TRIFURCON TERMINAL CRIMP TYPE, .156 CENTERS 18 TO 20 AWG WIRE MOLEX INCORPORATED
		mm	INCH	DRAWN BY	DATE	---	INCH		
		4 PLACES ± --- ± ---	GUZIK	11/15/89					
		3 PLACES ± --- ± .010	CHECKED BY	DATE					
2 PLACES ± 0.25 ± .015	PATEL	11/15/89	APPROVED BY	DATE	11/15/89	MATERIAL NO.	DOCUMENT NO.	SHEET NO.	
1 PLACE ± 0.36 ± ---	LENZ					SD-6838		1 OF 2	
DRAFT WHERE APPLICABLE MUST REMAIN WITHIN DIMENSIONS		SEE CHART		THIS DRAWING CONTAINS INFORMATION THAT IS PROPRIETARY TO MOLEX INCORPORATED AND SHOULD NOT BE USED WITHOUT WRITTEN PERMISSION					

6838-(*)**		6838-A(*)**													
PART NO.	ENG. NO.	PART NO.	ENG. NO.	PART NO.	ENG. NO.	PART NO.	ENG. NO.	PART NO.	ENG. NO.	PART NO.	ENG. NO.	PART NO.	ENG. NO.	PART NO.	ENG. NO.
08-50-0187	6838-(P909)														
08-50-0189	6838-(P909)L	08-58-0187	6838-A(P558)												
08-50-0275	6838-(P909)-A	08-58-0189	6838-A(P558)L												
08-50-0026	6838-(P102)	08-60-0001	6838-A(132)												
	6838-(P102)L	08-60-0002	6838-A(132)L												
08-50-0028	6838-(102)	08-58-0102	6838-A(558)												
08-50-0029	6838-(102)L		6838-A(558)L												
		08-58-0108	6838-A(503)												
		08-58-0109	6838-A(503)L												
		08-52-0112	6838-A(P909)												
		08-52-0113	6838-A(P909)L												
		08-50-0024	6838-A(102)												
		08-50-0251	6838-A(102)L												
		08-58-0105	6838-A(P555)												
		08-58-0106	6838-A(P555)L												
		08-58-0110	6838-A(P561)												
		08-58-0111	6838-A(P561)L												
		08-58-0118	6838-A(561)												
		08-58-0119	6838-A(561)L												
		08-58-0131	6838-A(550)												
		08-58-0132	6838-A(550)L												

UPDATE TITLE BLOCK DEC NO: UCP2008-0005 2007/07/03 DRAWN BY: JORWANDARR 2007/07/09 CHECKED BY: CHUCK BELL 2007/07/09 APPROVED BY: APPRELSMITH 2007/07/09 REV DESCRIPTION	QUALITY SYMBOLS ▽=0 ▽=0	GENERAL TOLERANCES (UNLESS SPECIFIED) <table border="1"> <tr> <th></th> <th>mm</th> <th>INCH</th> </tr> <tr> <td>4 PLACES</td> <td>± .005</td> <td>± .0005</td> </tr> <tr> <td>3 PLACES</td> <td>± .005</td> <td>± .0005</td> </tr> <tr> <td>2 PLACES</td> <td>± .005</td> <td>± .0005</td> </tr> <tr> <td>1 PLACE</td> <td>± .005</td> <td>± .0005</td> </tr> </table>		mm	INCH	4 PLACES	± .005	± .0005	3 PLACES	± .005	± .0005	2 PLACES	± .005	± .0005	1 PLACE	± .005	± .0005	DIMENSION STYLE IN/MM DRAWN BY: GUZIK DATE: 11/15/89 CHECKED BY: PATTEL DATE: 11/15/89 APPROVED BY: LENZ DATE: 11/15/89	SCALE: --- DESIGN UNITS: INCH THIRD ANGLE PROJECTION	TITLE: TRIFURCON TERMINAL CRIMP TYPE, .156 CENTERS 18 TO 20 AWG WIRE MOLEX INCORPORATED	MATERIAL NO.: SEE CHART DOCUMENT NO.: SD-6838 SHEET NO.: 2 OF 2
		mm	INCH																		
	4 PLACES	± .005	± .0005																		
	3 PLACES	± .005	± .0005																		
2 PLACES	± .005	± .0005																			
1 PLACE	± .005	± .0005																			
DRAFT WHERE APPLICABLE MUST REMAIN WITHIN DIMENSIONS		THIS DRAWING CONTAINS INFORMATION THAT IS PROPRIETARY TO MOLEX INCORPORATED AND SHOULD NOT BE USED WITHOUT WRITTEN PERMISSION																			